



GUIDELINES ON ASCERTAINING ENERGY CONSUMER

[GP/ST/No.44/2024]

Registration Record

DOCUMENT CONTROL		
REGISTRATION NO.	REVISION DATE	REMARKS



**ENERGY EFFICIENCY AND CONSERVATION ACT 2024
[Act 861]**

GUIDELINES ON ASCERTAINING ENERGY CONSUMER

GP/ST/No.44/2024

IN exercise of the powers conferred by paragraph 3(2)(a) and section 67 of the Energy Efficiency and Conservation Act 2024 [Act 861], the Commission issues the following guidelines:

Citation and commencement

1. These guidelines may be cited as the Guidelines on Ascertaining Energy Consumer.
2. These Guidelines shall come into operation on 1 January 2025.

Purpose

3. The purpose of these Guidelines are—
 - (a) to establish the principles, rules, and mechanisms for determining whether a person qualifies as an energy consumer under the Energy Efficiency and Conservation Act 2024 [Act 861], based on their energy consumption and the circumstances surrounding their energy use; and
 - (b) to determine the boundary as an energy consumer.

Dated: 30 December 2024

DATO' IR. TS. ABDUL RAZIB BIN DAWOOD

Chief Executive Officer

Energy Commission

TABLE OF CONTENTS

1.	SCOPE.....	4
2.	INTERPRETATION	4
3.	INTRODUCTION.....	6
4.	DETERMINING BOUNDARY OF ENERGY CONSUMPTION.....	6
5.	BOUNDARY OF ENERGY CONSUMER.....	8
6.	CIRCUMSTANCES IN DETERMINING BOUNDARY OF ENERGY CONSUMPTION AND ENERGY CONSUMER	11
	6.1 ENERGY OR ENERGY RESOURCES RECEIVED FROM A SUPPLIER OF ENERGY AT ONE OR MORE MEASURING POINT	11
	6.2 ENERGY OR ENERGY RESOURCES WHICH ARE ACQUIRED FOR ONWARDS SALE OR DISTRIBUTION TO OTHER PERSONS WITHOUT CONVERSION OF ENERGY OR ENERGY RESOURCES.	20
	6.3 ENERGY OR ENERGY RESOURCES WHICH ARE ACQUIRED FOR ONWARDS SALE OR DISTRIBUTION TO OTHER PERSONS WITH CONVERSION OF ENERGY OR ENERGY RESOURCES.....	21
	6.4 ENERGY RESOURCES USED AS FEEDSTOCK.....	24
7.	APPENDIX	25
	APPENDIX A: CONVERSION COEFFICIENTS AND EQUIVALENCE	25

1. SCOPE

1.1. These Guidelines are for the purpose of ascertaining—

- (a) the energy consumer who are subjected under paragraph 3(2)(a) of the Energy Efficiency and Conservation Act 2024 [Act 861]; and
- (b) the boundary as an energy consumer.

2. INTERPRETATION

2.1. In these Guidelines, the following terms shall have the following meanings:

“Act”	means the Energy Efficiency and Conservation Act 2024 [Act 861];
“cogeneration”	means simultaneous production of electricity and thermal energy from a single energy resources;
“Commission”	has the meaning assigned to it under the Energy Efficiency and Conservation Act 2024 [Act 861];
“district cooling system”	means a centralized infrastructure that provides chilled water or cool air to multiple buildings or facilities within a specific area or district;
“feedstock”	means any energy resources which is used as input in industrial processes or manufacturing operations to produce a product or output;
“measuring point”	means the point of physical connection of the device measuring the energy-related parameters where the energy consumption is measured;
“private installation licensee”	means a licensee for a private installation under the Electricity Act 1990 [Act 447];

“public installation licensee”	means a licensee for a public installation under the Electricity Act 1990 [Act 447];
“related corporation”	has the meaning assigned to it in section 2 of the Companies Act 2016 [Act 777];
“same compound”	means a specific area or property where multiple buildings or factories are situated in close proximity to each other within the boundaries of a single land parcel;
“supplier of energy”	means any person who supply the energy or energy resources as specified in the First and Second Schedule of the Act which include but not limited to— <ul style="list-style-type: none">(a) the licensee under the Electricity Supply Act 1990 [Act 447]; or (b) the licensee under the Gas Supply Act 1993 [Act 501];
“waste heat recovery”	means a technology that capture and reuse the generated heat produced as a by-product of industrial processes and then converted into any form of energy.

3. INTRODUCTION

- 3.1. These Guidelines are issued to determine whether a person is an energy consumer to whom this Act applies under paragraph 3(2)(a) of the Act.
- 3.2. These Guidelines are applicable to any energy consumer whose energy consumption for a period of twelve consecutive months equals to or exceeds 21,600 gigajoule (GJ).

4. DETERMINING BOUNDARY OF ENERGY CONSUMPTION

- 4.1. The energy consumption of a person is determined—
 - (a) by measuring the consumption of energy or energy resources received from a supplier of energy at one measuring point or more; or
 - (b) by measuring energy that is generated from solar photovoltaic or solar thermal energy resources at one measuring point or more.
- 4.2. The energy consumption referred to in paragraph 4.1 are converted into gigajoule (GJ) using the specific conversion formula in Appendix A.
- 4.3. In determining the energy consumption, the following shall be excluded:
 - (a) the energy or energy resources which are acquired for onwards sale or distribution to other persons; and
 - (b) the energy resources used as feedstock.
- 4.4. The example on the determination of the energy consumption of an energy consumer which consumes electricity and natural gas as energy or energy resources is illustrated in Figure 1.

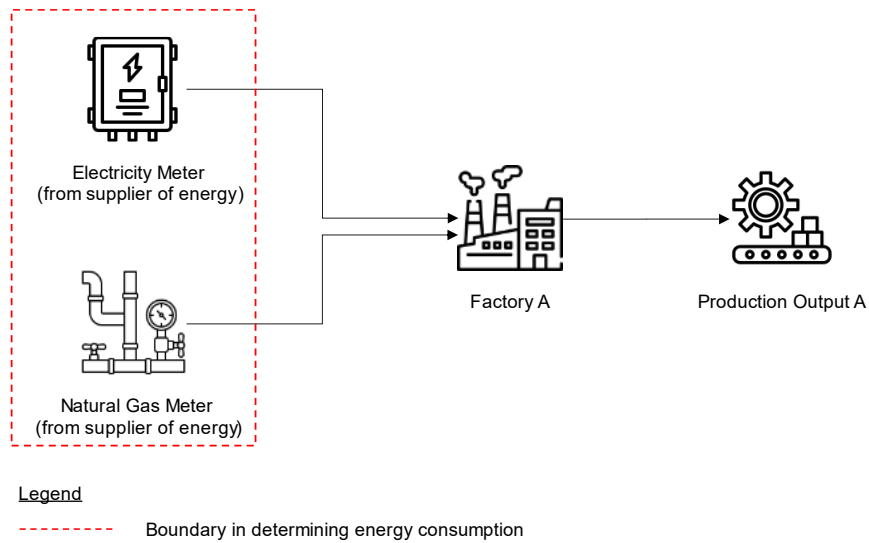

Figure 1: Boundary of energy consumption for Factory A.

Based on the conversion formula in Appendix A, conversion coefficients for electricity and natural gas are provided in Table 1 as follows:

Energy or Energy Resources	Conversion Coefficients
Electricity	0.0036 GJ/kWh
Natural Gas	1.055 GJ/mmbtu

Table 1: Conversion Coefficient for Electricity and Natural Gas.

Table 2 below shows the consumption of electricity and natural gas and its equivalent in gigajoule (GJ). The total energy consumption for both electricity and natural gas in gigajoule (GJ) is also calculated in the table as follows:

Year	Month	Electricity Meter		Natural Gas Meter		Total Energy [GJ]
		Electricity [kWh]	Energy [GJ]	Natural Gas [mmBtu]	Energy [GJ]	
2023	1	797,400	2,870.64	1,520	1,603.60	4,474.24
2023	2	649,314	2,337.53	1,275	1,345.13	3,682.66
2023	3	550,682	1,982.46	1,311	1,383.11	3,365.56
2023	4	668,803	2,407.69	1,713	1,807.22	4,214.91
2023	5	665,536	2,395.93	1,955	2,062.53	4,458.45
2023	6	777,885	2,800.39	1,058	1,116.19	3,916.58

2023	7	512,765	1,845.95	1,573	1,659.52	3,505.47
2023	8	778,102	2,801.17	1,083	1,142.57	3,943.73
2023	9	797,638	2,871.50	1,482	1,563.51	4,435.01
2023	10	633,583	2,280.90	1,278	1,348.29	3,629.19
2023	11	754,398	2,715.83	1,211	1,277.61	3,993.44
2023	12	737,340	2,654.42	1,828	1,928.54	4,582.96
Total		8,323,446	29,964.41	17,287.00	18,237.79	48,202.19

Table 2: Energy consumption for Factory A.

Factory A's total energy consumption is 48,202.19 gigajoule (GJ) which exceeds the threshold of 21,600 gigajoule (GJ). Therefore, Factory A is an energy consumer under this Act.

5. BOUNDARY OF ENERGY CONSUMER

- 5.1. The boundary of an energy consumer comprises of the power appliances, equipment, machinery, systems, infrastructure or processes for their daily operations in respect of the energy consumption by the energy consumer.
- 5.2. Figure 2 illustrates the usual boundary as an energy consumer for industry sector as follows:

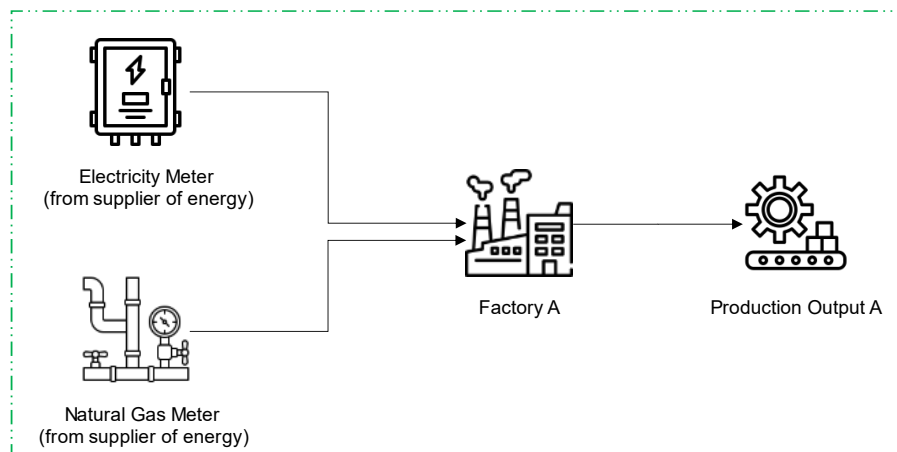

Legend
 - - - - - Boundary as an energy consumer

Figure 2: Usual boundary as an energy consumer for industry sector.

- 5.3. Figure 3 illustrates an example of usual boundary as an energy consumer for commercial sector as follows:

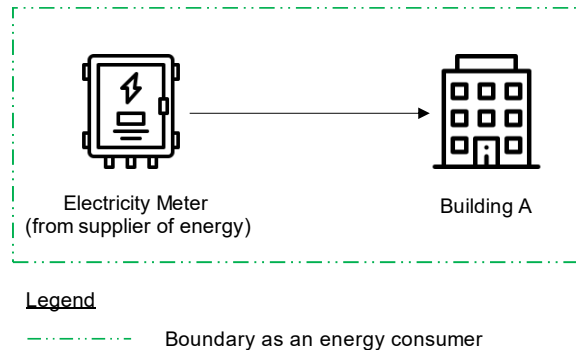

Figure 3: Usual boundary as an energy consumer for commercial sector.

- 5.4. Two or more energy consumer may be combined to become one energy consumer provided they are all located within the same compound and are all related corporation.
- 5.5. Figure 4 illustrates how two or more energy consumers may be combined to become one energy consumer. Factory A has two plants namely Plant 1 and Plant 2 which are related corporation and both plants are energy consumer located within the same compound. Such illustration is as follows:

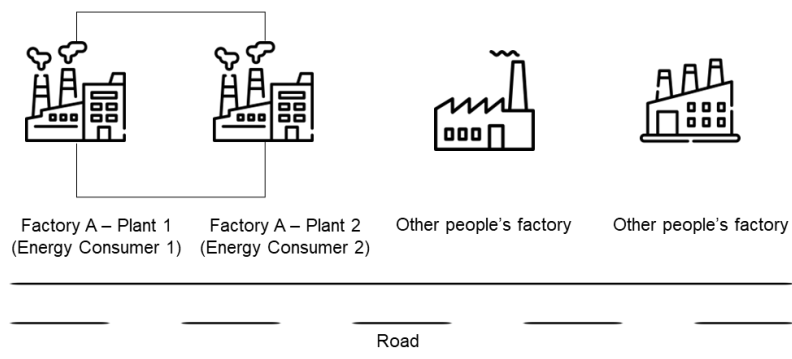

Figure 4: Two or more energy consumers can be combined to become one energy consumer.

Explanation:

- (a) *Factory A – Plant 1 is located next to the Factory A – Plant 2.*

- (b) *There is an access road that connects the Factory A – Plant 1 and Factory A – Plant 2.*
- (c) *Therefore, Factory A – Plant 1 (energy consumer 1) and Factory A – Plant 2 (energy consumer 2) can be combined to become one energy consumer, instead of two energy consumers.*

5.6. Figure 5 illustrates how two or more energy consumers cannot be combined to become one energy consumer. Factory B has two plants namely Plant 1 and Plant 2 which are related corporation and both plants are energy consumer not located within the same compound and separated by other people's factory. Such illustration is as follows:

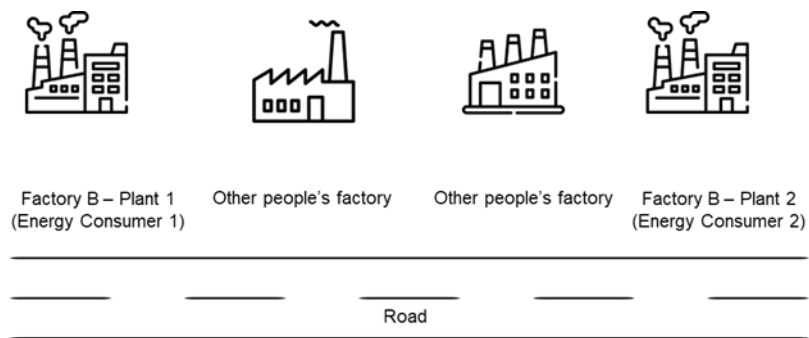

Figure 5: Two or more energy consumers cannot be combined to become one energy consumer.

Explanation:

- (a) *Factory B – Plant 2 is located along the same road as Factory B – Plant 1, but it is separated by two other factories owned by other people.*
- (b) *Factory B – Plant 2 is not within the same compound as the Factory B – Plant 1 as it is separated by factories owned by other people.*
- (c) *Therefore, Factory B – Plant 1 (energy consumer 1) and Factory B – Plant 2 (energy consumer 2) shall remain as two separate energy consumers and cannot be combined to become one energy consumer.*

6. CIRCUMSTANCES IN DETERMINING BOUNDARY OF ENERGY CONSUMPTION AND ENERGY CONSUMER

6.1 ENERGY OR ENERGY RESOURCES RECEIVED FROM A SUPPLIER OF ENERGY AT ONE OR MORE MEASURING POINT

6.1.1 Where one or more energy or energy resources are measured at one or more measuring point and supplied to a person for the purpose of carrying out his activity, business or trade, such person shall be treated as one energy consumer. The scenarios are illustrated in Figure 6 to Figure 6F, respectively as follows:

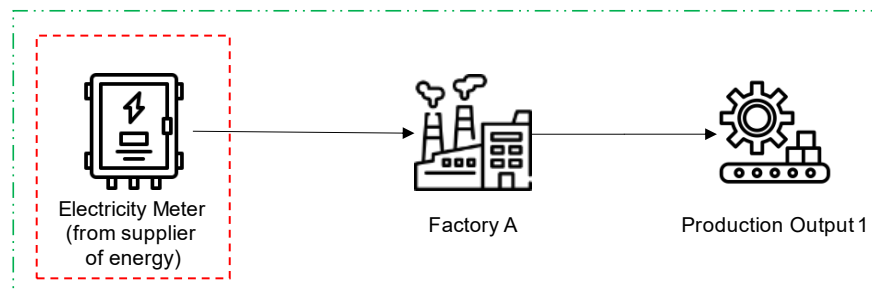

Legend

- - - - - Boundary in determining energy consumption
- . - . - Boundary as an energy consumer

Figure 6: One energy or energy resources measured at one or more measuring point, supplied to a factory to produce a production output.

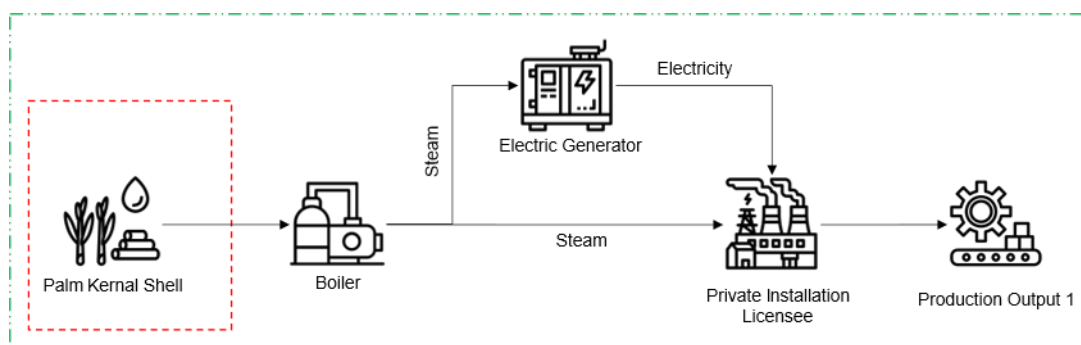

Legend

- - - - - Boundary in determining energy consumption
- . - . - Boundary as an energy consumer

Figure 6A: A private installation licensee used Palm Kernel Shell as their energy resources to generate electricity and operate the factory.

GUIDELINES ON ASCERTAINING ENERGY CONSUMER

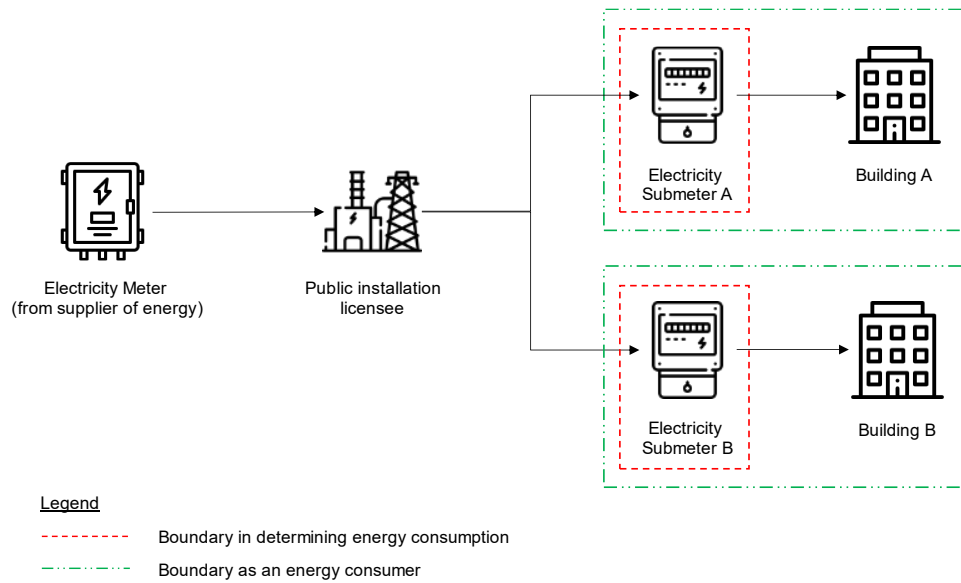

Figure 6B: Tenant or consumer who received the energy from public installation licensee for the purpose of distribution.

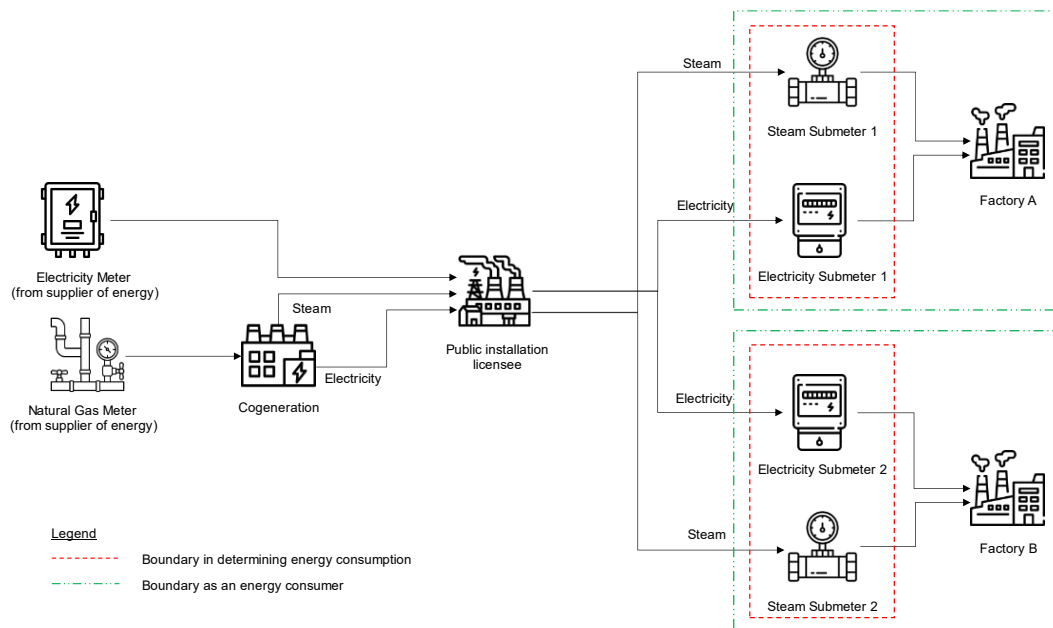

Figure 6C: Tenant or consumer who received the energy from public installation licensee with cogeneration.

GUIDELINES ON ASCERTAINING ENERGY CONSUMER

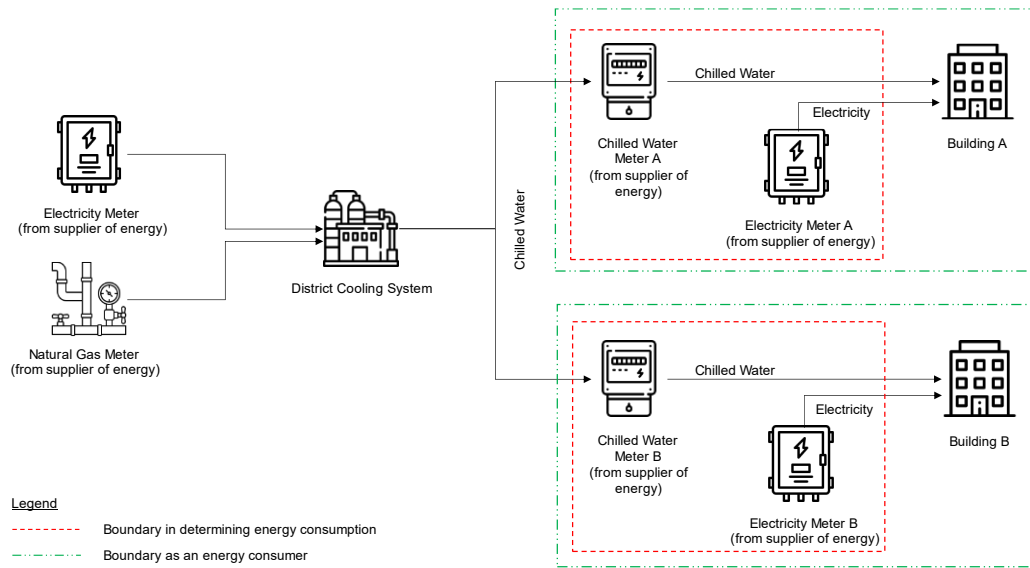

Figure 6D: Tenant or consumer who received the energy product (chilled water) from district cooling system

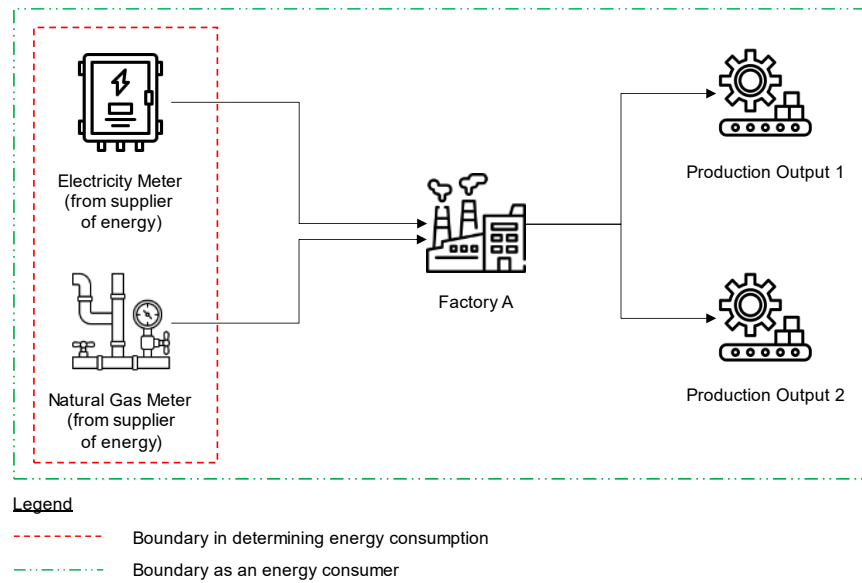

Figure 6E: Two or more energy or energy resources measured at two or more measuring point and supplied to a factory to produce production output.

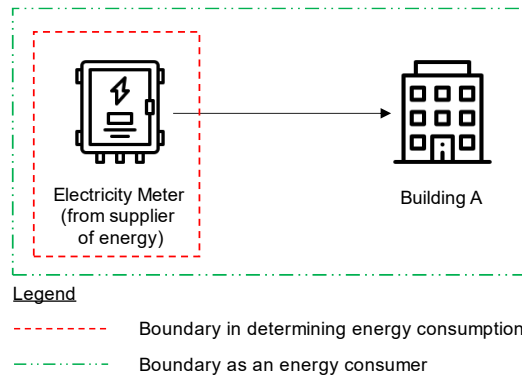

Figure 6F: One energy or energy resources measured at one measuring point, supplied to a building for their daily operation.

6.1.2 Where one or more energy or energy resources measured at one or more measuring point, supplied to a different person but such person is a related corporation and located within the same compound to produce a production output or for their daily operation, each person will be treated as one energy consumer. The scenario is illustrated in Figure 7 as follows:

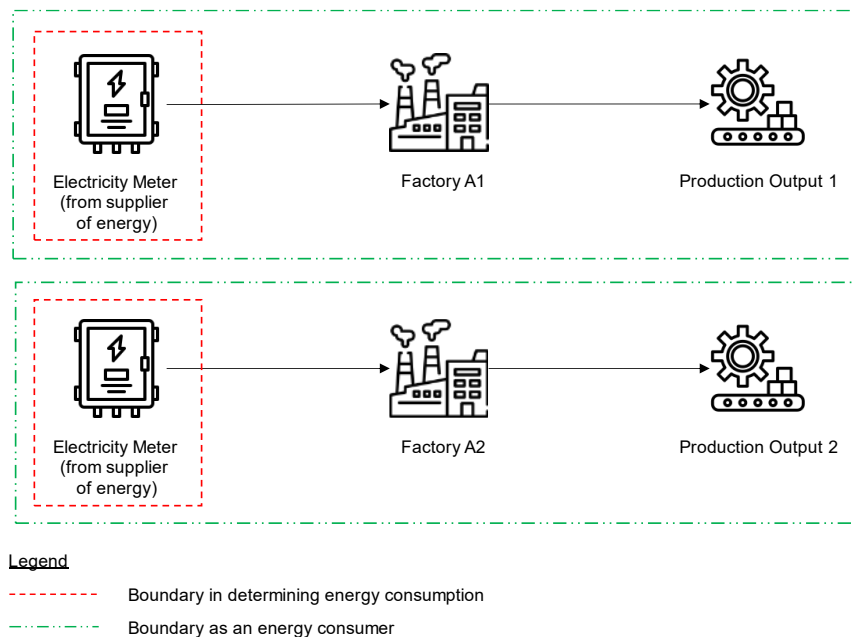

Figure 7: One or more energy or energy resources measured at one or more measuring point, supplied to two factories (related corporation and located within the same compound) to produce a production output at each factory.

6.1.3 Notwithstanding paragraph 6.1.2, any person who is a related corporation and located within the same compound referred to in paragraph 6.1.2 may be treated as one energy consumer upon request to the Commission. The scenario is illustrated in Figure 8 as follows:

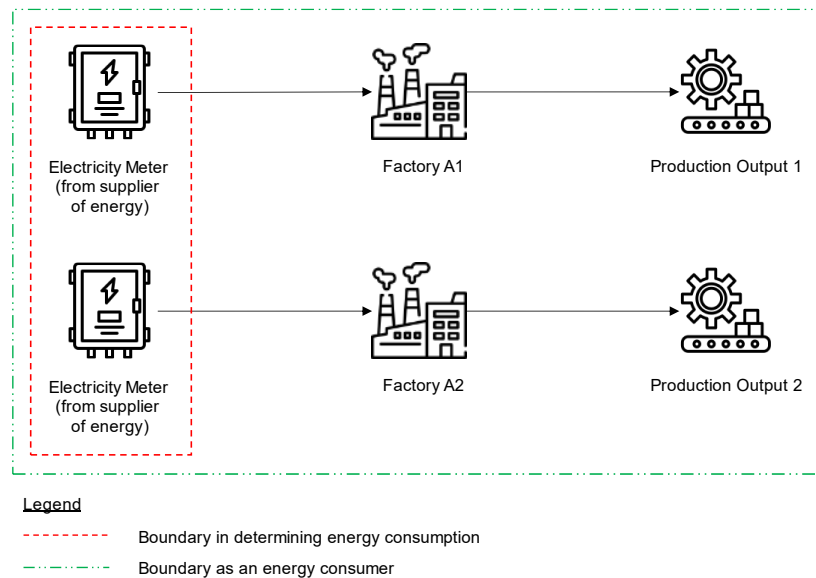

Figure 8: Two energy or energy resources measured at different measuring point, supplied to two factories which are related corporation and within the same compound, to produce a production output at each factory.

6.1.4 In a scenario where one or more energy or energy resources measured at one or more measuring point, supplied through a submetering to a different person who is not a related corporation but located within the same compound, to produce a production output or for their daily operation, such person will be treated as one energy consumer. The determination of energy consumption would be based on the energy or energy resources measured at the measuring point and shall not be measured at the submeter. The scenarios are illustrated in Figure 9 and Figure 10, respectively as follows:

GUIDELINES ON ASCERTAINING ENERGY CONSUMER

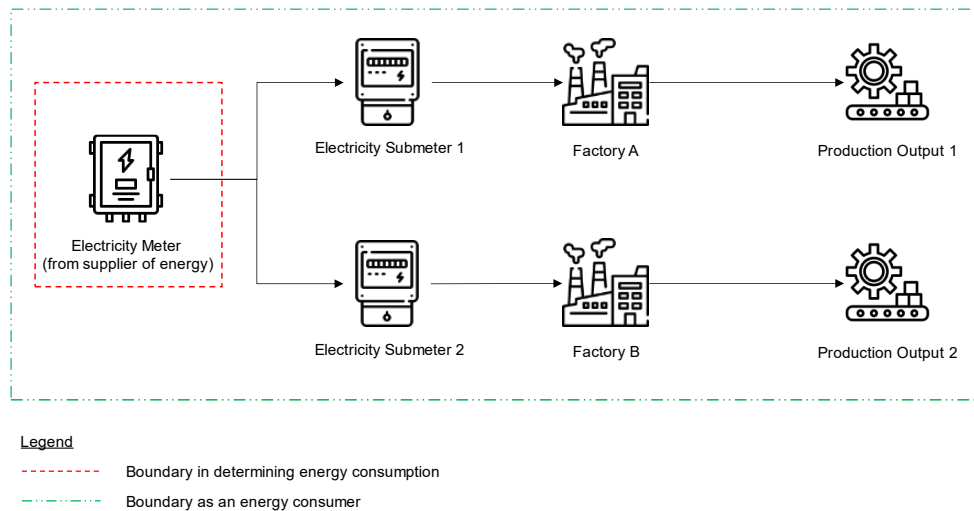

Figure 9: One energy or energy resources measured at one measuring point, supplied through a submetering to a different person who is not a related corporation but located within the same compound, to produce a production output.

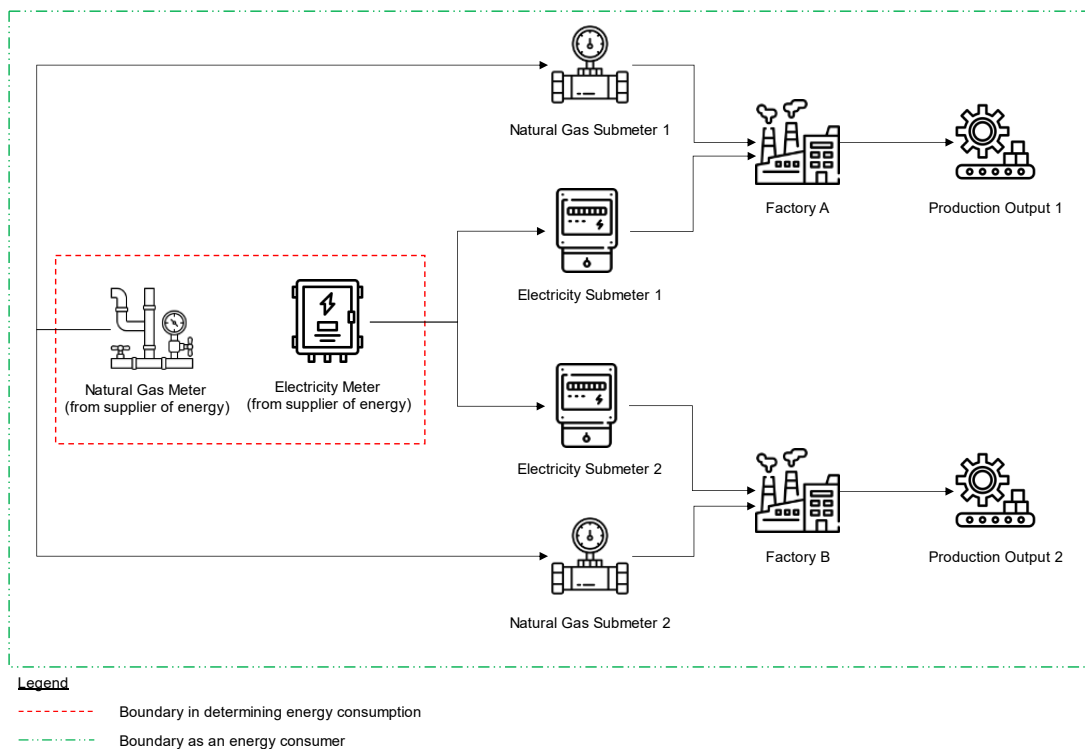

Figure 10: One or more energy or energy resources measured at one or more measuring point, supplied through a submetering to a different person who is not a related corporation but located within the same compound, to produce a production output.

- 6.1.5 In a scenario where a person is supplied with energy which is generated from solar photovoltaic or solar thermal, such energy supplied is included in the determination of energy consumption. Such person shall be treated as one energy consumer.
- 6.1.6 The energy referred to in paragraph 6.1.5 which is exported to the grid system shall be excluded from the determination of energy consumption. For the purposes of determination of energy consumption, the net energy consumption shall be calculated as shown in Equation 1 as follows:

$$\text{Net energy consumption} = \text{Energy generated from solar photovoltaic or solar thermal energy resources} - \text{Energy exported to grid system}$$

Equation 1

The scenarios referred to in paragraph 6.1.5 and 6.1.6 are illustrated in Figure 11.

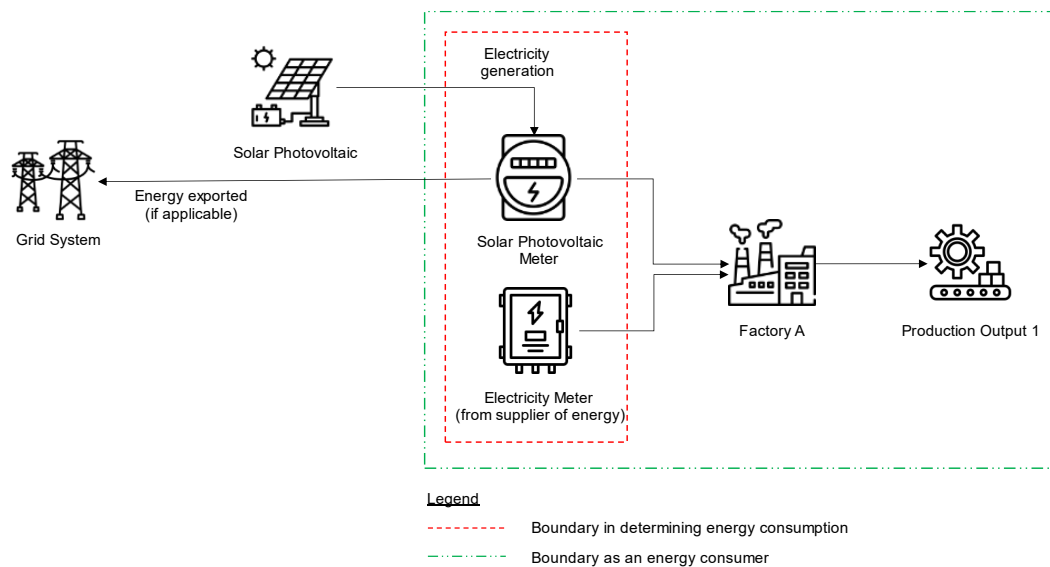

Figure 11: A factory supplied with energy generated from solar photovoltaic and energy or energy resources by supplier of energy measured at one or more measuring point.

6.1.7 Where the cogeneration system supplied energy to any person for private use, the determination of energy consumption would be based on the energy or energy resources measured at one or more measuring point supplied to the cogeneration. In such situation, the person shall be treated as one energy consumer.

6.1.8 Where there is another energy or energy resources supplied to any person for private use and measured at a measuring point other than cogeneration, such energy or energy resources supplied shall be included in the determination of energy consumption and such person will be treated as one energy consumer. The scenarios are illustrated in Figure 12 and 13, respectively as follows:

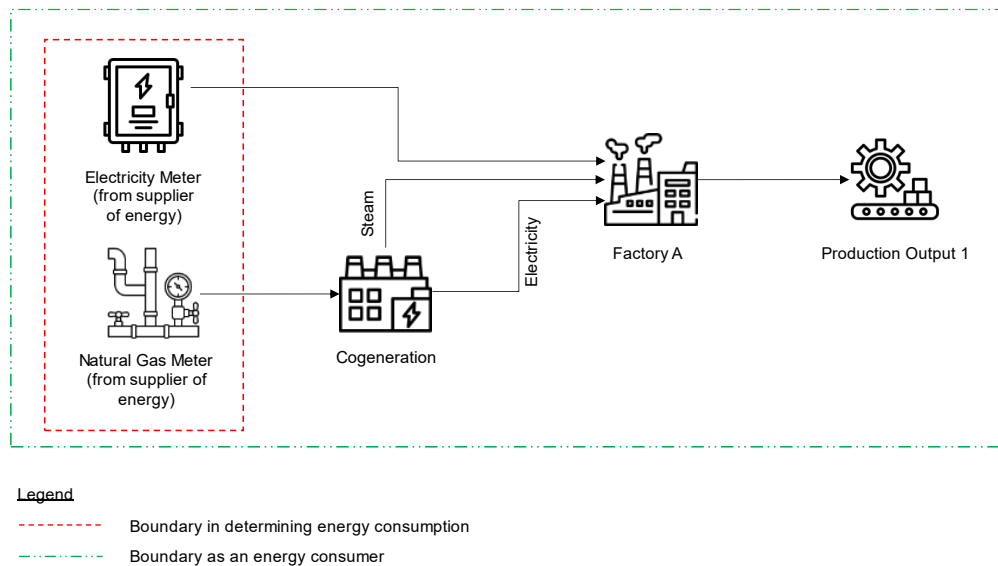

Figure 12: A factory is supplied with energy or energy resources measured at a measuring point and a cogeneration system to produce a production output.

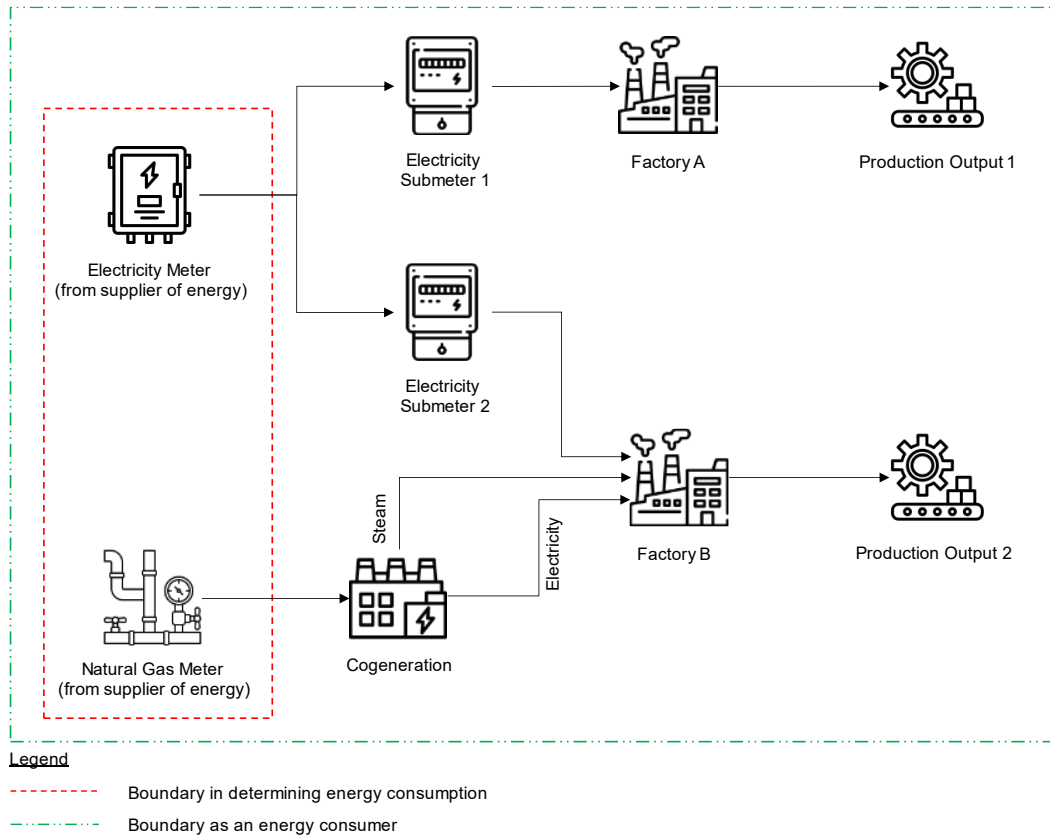
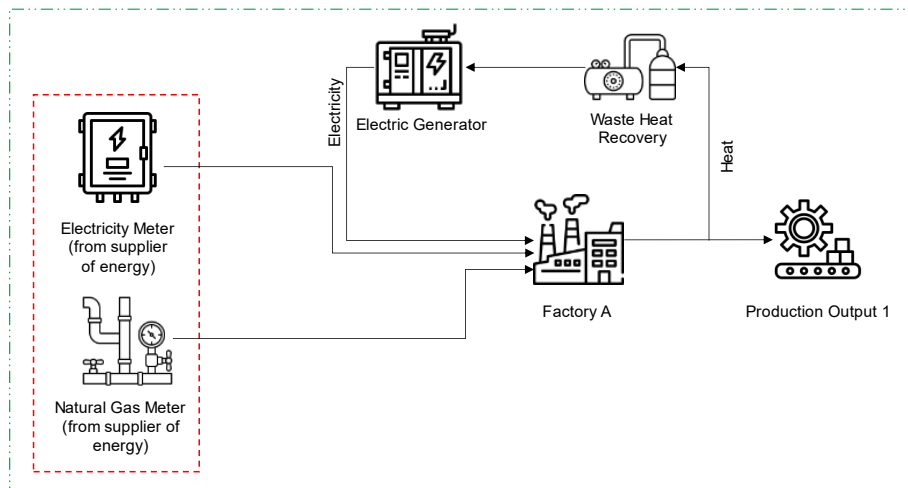

Figure 13: One or more energy or energy resources supplied to different factory through submeter and cogeneration to produce a production output.

6.1.9 Where there is a waste heat recovery process which generates energy, such energy will be excluded from the determination of energy consumption. Such person shall be treated as one energy consumer. The scenario is illustrated in Figure 14 as follows:



Legend

- - - - - Boundary in determining energy consumption
- - - - - Boundary as an energy consumer

Figure 14: A factory is installed with waste heat recovery system where waste heat generated during its manufacturing processes is captured, converted into electrical energy, and supplied back to the factory.

6.2 ENERGY OR ENERGY RESOURCES WHICH ARE ACQUIRED FOR ONWARDS SALE OR DISTRIBUTION TO OTHER PERSONS WITHOUT CONVERSION OF ENERGY OR ENERGY RESOURCES.

6.2.1 Where a public installation licensee for the purpose of distribution is supplied with the energy by supplier of energy, the determination of energy consumption of such public installation licensee would be based on the net energy consumption measured at measuring point supplied to such public installation licensee. In such scenario, the public installation licensee shall be treated as one energy consumer.

6.2.2 For the purposes of determination of energy consumption, the net energy consumption referred to in paragraph 6.2.1 shall be calculated as shown in Equation 2 as follows:

$$\begin{aligned}
 & \text{Net energy consumption [GJ]} \\
 &= \sum \text{Energy received from supplier of energy [GJ]} \\
 &- \sum \text{Energy supplied to the tenants or consumers [GJ]}
 \end{aligned}$$

Equation 2

The scenario referred to in paragraph 6.2.1 are illustrated in Figure 15 as follows:

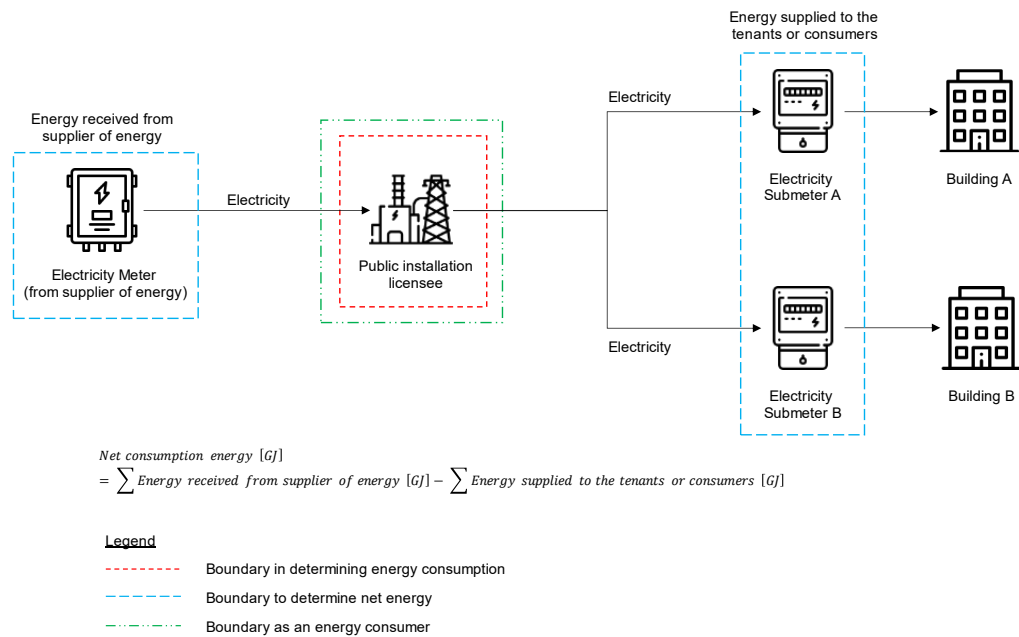

Figure 15: Energy supply received by the public installation licensee for the purpose of distribution.

6.3 ENERGY OR ENERGY RESOURCES WHICH ARE ACQUIRED FOR ONWARDS SALE OR DISTRIBUTION TO OTHER PERSONS WITH CONVERSION OF ENERGY OR ENERGY RESOURCES.

6.3.1 Where a person is supplied with energy generated from an energy conversion plant which converts energy or energy resources into different forms of energy or energy resources, for example gas cogeneration system that converts natural gas into steam and electricity, for the purpose of distribution to their tenant or consumer, the determination of energy consumption would be based on the energy or energy resources measured at one or more measuring point

supplied to the energy conversion plant. In such situation, the person shall be treated as one energy consumer.

6.3.2 Where there is another energy or energy resources supplied to a person and measured at a measuring point other than energy conversion plant, the determination of energy consumption of such person would consist of another energy or energy resources supplied. In such situation, the shall be treated as one energy consumer.

The scenarios referred to in paragraphs 6.3.1 and 6.3.2 are illustrated in Figure 16, 17 and 18 as follows:

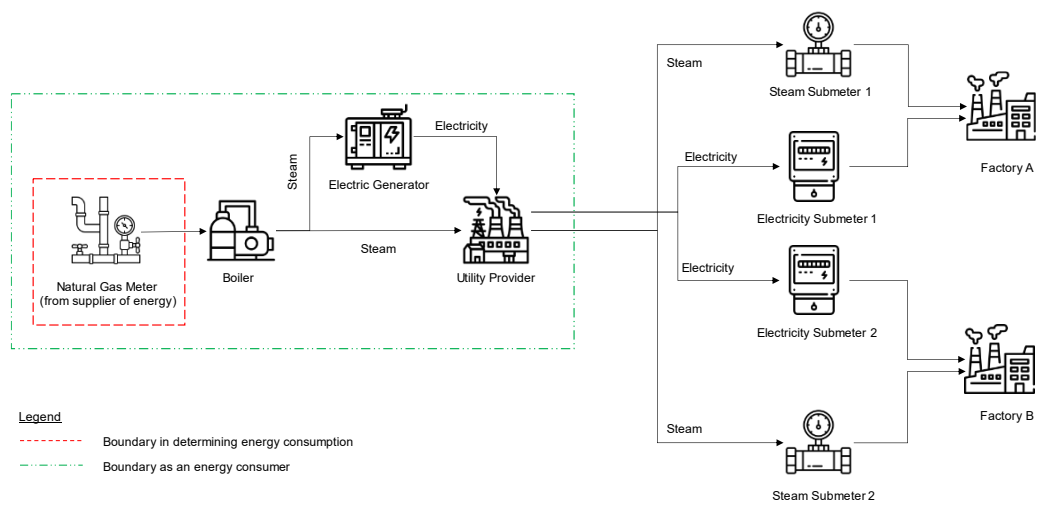

Figure 16: A utility provider operates a boiler system to generate steam and electricity for distribution

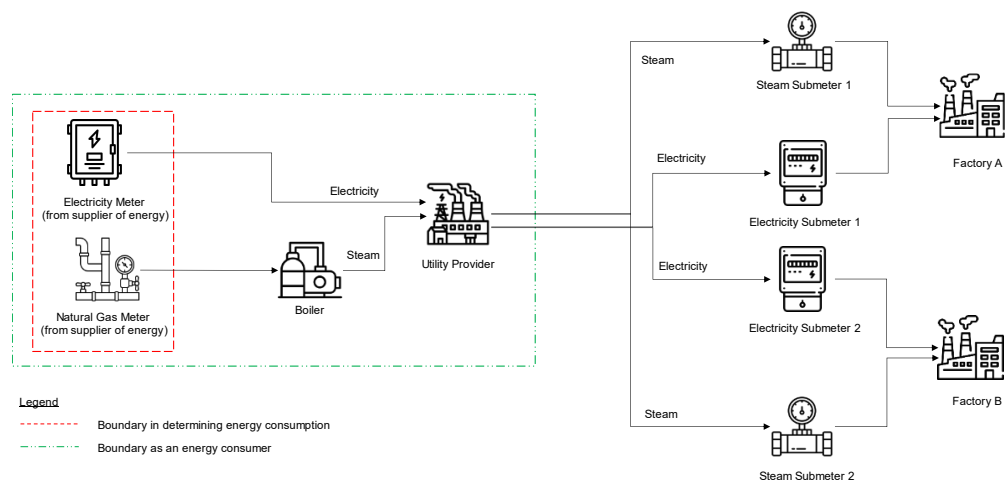

Figure 17: A utility provider operates a boiler system and supplied with another energy or energy resources separately, to generate steam and electricity for distribution

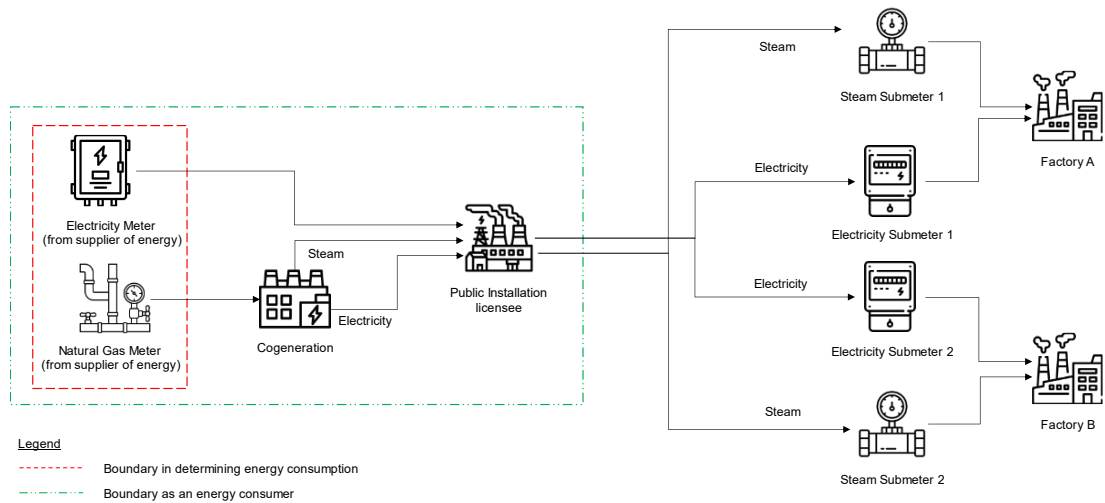

Figure 18: Public installation licensee with cogeneration.

6.3.3 Where any person supplied with energy or energy resources by the supplier of energy and converting the energy or energy resources to different form of energy or energy resources for the purpose of distribution to their tenant or consumer, the determination of energy consumption of such person shall be based on the energy or energy resources measured at one or more measuring point supplied to the person. In such situation, the person shall be treated as one energy consumer.

The scenario referred to in paragraph 6.3.3 are illustrated in Figure 19 as follows:

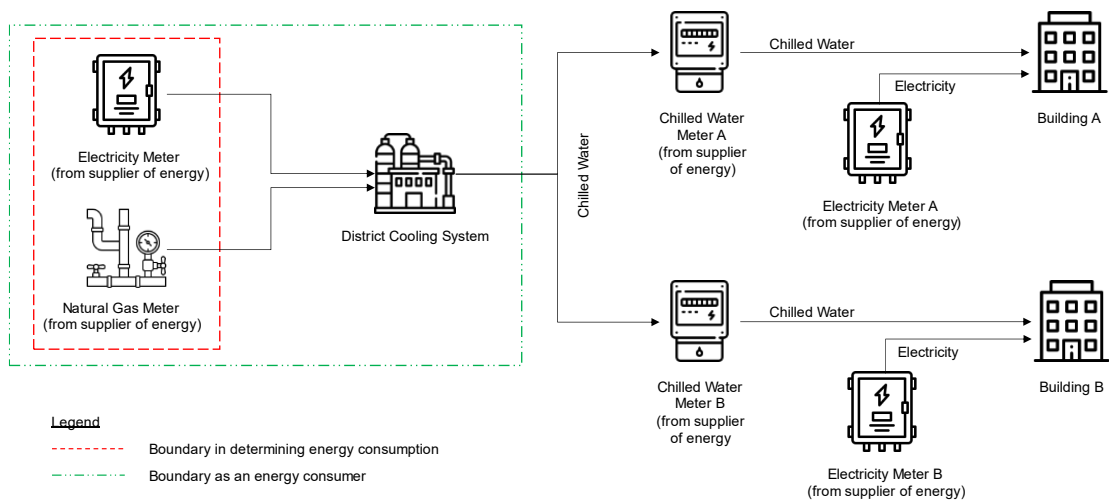

Figure 19: District cooling system produces a chilled water and then distributed the chilled water to their tenants or consumer.

6.4 ENERGY RESOURCES USED AS FEEDSTOCK

Any person who is supplied with energy resources by supplier of energy where part of energy resources supplied is stored as feedstock which is used as inputs in the manufacturing or production process to create a product or output, the determination of energy consumption shall exclude part of the energy resources stored as feedstock. In such situation, the person shall be treated as one energy consumer and the scenario is illustrated in Figure 20 as follows:

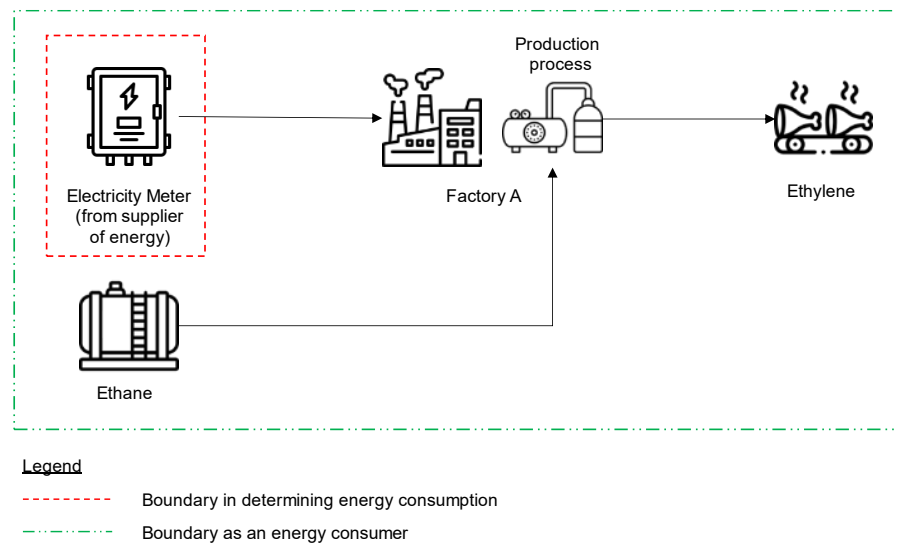

Figure 20: Ethane is used as feedstock to the manufacturing or production process to produce Ethylene.

7. APPENDIX

APPENDIX A: CONVERSION COEFFICIENTS AND EQUIVALENCE

Energy Resources

<i>Energy Resources</i>	<i>Conversion Coefficients/Equivalence</i>
Hard coal	29.3076 GJ/tonne
Coke or oven coke	26.3768 GJ/tonne
Gas coke	26.3768 GJ/tonne
Brown coal coke	19.6361 GJ/tonne
Pattern fuel briquettes	29.3076 GJ/tonne
Lignite or brown coal	11.2834 GJ/tonne
Peat	9.5250 GJ/tonne
Lignite briquettes	19.6361 GJ/tonne
Liquefied natural gas (LNG)	45.1923 GJ/tonne
Butane	50.393 GJ/tonne
Propane	49.473 GJ/tonne
Liquefied Petroleum Gas (LPG) (Mixture of Butane and Propane)	0.045544 GJ/kg
	0.13640 GJ/m ³
Natural gas	1000 GJ/mscf
	1.055 GJ/mmbtu
	0.02898 GJ/m ³
Ethane	1,067.82 GJ/mscf
Methane	1,131.31 GJ/mscf
Solar photovoltaic	0.0036 GJ/kWh
Solar thermal	0.0036 GJ/kWh
Biogas	50.4 GJ/tonne
Biodiesel	27.0 GJ/tonne
Charcoal	29.5 GJ/tonne
Empty fruit bunch (EFB)	18.8 GJ/tonne
Fuelwood	15.6 GJ/tonne
Mesocarp Fibre	18.8 GJ/tonne
Palm kernel shell (PKS)	20.1 GJ/tonne

Energy

<i>Energy</i>	<i>Conversion Coefficients/Equivalence</i>
Electricity	0.0036 GJ/kWh
Chilled water	0.01266 GJ/RTH
Steam (saturated condition)	
(a) at 10 bar steam pressure	2.78 GJ/tonne
(b) at 8 bar steam pressure	2.77 GJ/tonne
(c) at 6 bar steam pressure	2.76 GJ/tonne
Hot water (saturated condition)	
(a) at 80°C hot water temperature	0.335 GJ/tonne
(b) at 90°C hot water temperature	0.377 GJ/tonne